

## FEATURES

- 0 - 5 to 0 - 300 psi
- Low Cost Sensor Element
- Internal Temperature Compensation
- Differential, Gage and Absolute

## APPLICATIONS

- Pneumatic Controls
- Automotive Diagnostics
- Medical Equipment
- Dental Equipment
- Environmental Controls

## GENERAL DESCRIPTION

The SCC series offer an extremely low cost sensor element with a temperature stable output when driven with a constant current source. These integrated circuit sensors were designed for extremely cost sensitive applications where precise accuracy over a wide temperature range is not required. This series is intended for use with non-corrosive, non-ionic working fluids such as air and dry gases.

Absolute devices have an internal vacuum reference and an output voltage proportional to applied pressure. The differential devices allow application of pressure to either side of the diaphragm and the devices are thereby available to measure both differential and/or gage pressures.

This product is packaged either in SenSym's standard low cost chip carrier "button" package, a plastic ported "N" package, a metal package or a dual inline package (DIP). All packages are designed for applications where the sensing element is to be integral to the OEM equipment. These packages can be O-ring sealed, epoxied, and/or clamped onto a pressure fitting. A closed bridge four-pin SIP configuration is

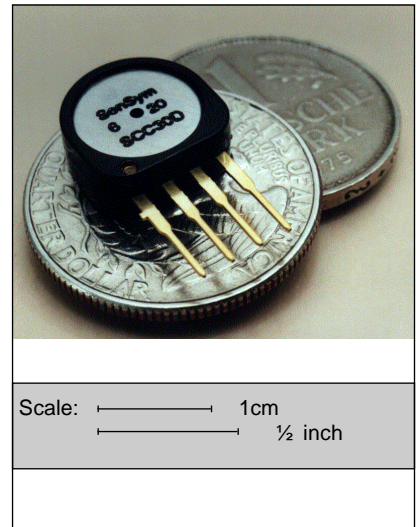

provided for electrical connection to the button package. The TO can and the DIP offer a 5-pin open bridge configuration.

## EQUIVALENT CIRCUIT

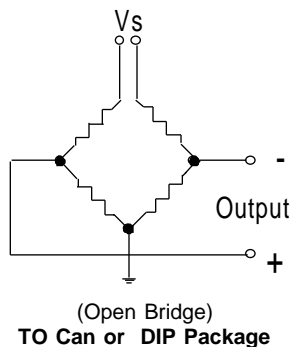
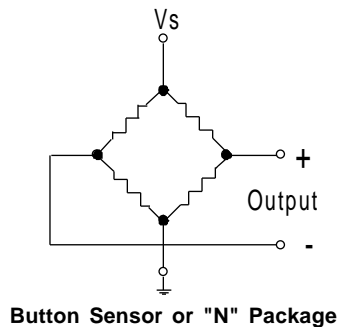

## ELECTRICAL CONNECTIONS

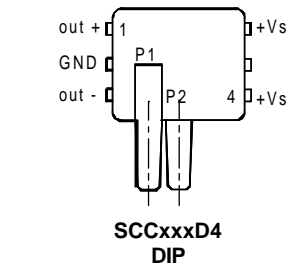
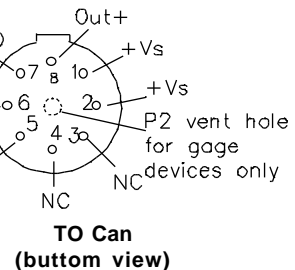
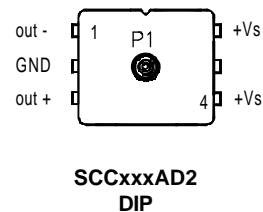
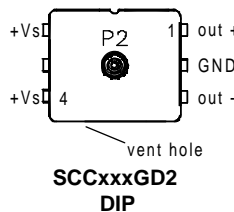
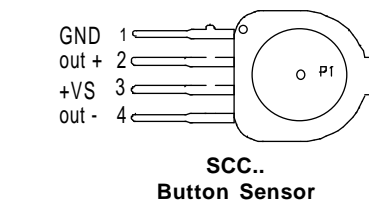

The polarity indicated is for pressure applied to  
 SCC.../SCC...N : P1 (forward gage)  
 SCC...ASO/GSO : P1 (forward gage)  
 SCC...DD4 : P2 (backward gage)

SCC...GD2 : P2 (backward gage)  
 SCC...AD2 : P1 (forward gage)

### PRESSURE SENSOR CHARACTERISTICS

#### Maximum Ratings (For All Devices)

Supply Current, $I_s$	1.5 mA
Temperature Ranges	
Compensated	0°C to +50°C
Operating	-40°C to +85°C
Storage	-55°C to +125°C
Humidity	0 to 100 %RH
Lead Temperature (soldering 4 sec)	250°C
Common-Mode Pressure	150 psi

#### Performance Characteristics (Individual Models) $I_s = 1.0 \text{ mA}$ , $T_A = 25^\circ\text{C}^1$

Part Number	Operating Pressure Range	Maximum Over Pressure	Accuracy <sup>2</sup>	Effect On Span <sup>3</sup> (0°C-50°C)	Effect On Offset <sup>4</sup> (0°C-50°C)	Full-Scale Span <sup>5</sup> (mV)
SCC05(D,G)	0-5 psid(g)	20 psi	0.50%	1.50%	2.00%	25-65
SCC15A	0-15 psia	30 psia	0.50%	1.50%	2.00%	30-95
SCC15(D,G)	0-15 psid(g)	30 psi	0.50%	1.50%	2.00%	40-95
SCC30(A,D,G)	0-30 psid(g)	60 psi	0.50%	1.50%	2.00%	60-150
SCC100A	0-100 psia	150 psia	0.50%	1.50%	2.00%	85-225
SCC100(D,G) <sup>9</sup>	0-100 psig	150 psig	0.50%	1.50%	2.00%	85-225
SCC300A	0-300 psia	450 psia	0.50%	1.50%	2.00%	50-120

#### Performance Characteristics (All Models) $I_s = 1.0 \text{ mA}$ , $T_A = 25^\circ\text{C}$

Characteristics	Min.	Typ.	Max.	Unit
Zero Pressure Offset	-30.0	-10	20.0	mV
Combined, Linearity, Hysteresis, Repeatability <sup>2</sup>	---	0.25	0.50	%FSO
Temperature Effect on Span <sup>3, 8</sup>	---	0.25	1.50	%FSO
Temperature Effect on Offset <sup>4, 8</sup>	---	0.50	2.00	%FSO
Long Term Stability of Offset and Span <sup>6</sup>	---	0.10	---	%FSO
Response Time (10% to 90%) <sup>7</sup>	---	0.10	---	mSec
Input Impedance	4.00	5.00	6.50	k $\Omega$
Output Impedance	4.00	5.00	6.50	k $\Omega$

#### Specification Notes:

- Reference Conditions: Supply Current = 1.0 mA,  $T_A = 25^\circ\text{C}$ , Common-mode Line Pressure = 0 psig, Pressure Applied to P1, unless otherwise noted.
- Accuracy is the sum of Hysteresis and Linearity. Hysteresis is the maximum output difference at any point within the operating pressure range for increasing and decreasing pressure. Linearity refers to the best straight line fit as measured for the offset, full-scale and 1/2 full-scale pressure at 25°C.
- This is the maximum temperature shift for span when measured between 0°C and 50°C relative to the 25°C reading. Typical temperature coefficients for span and resistance are -2200 ppm/°C and +2200 ppm/°C respectively.
- This is the maximum temperature shift for offset when measured between 0°C and 50°C relative to the 25°C reading.
- Span is the algebraic difference between the output voltage at full-scale pressure and the output at zero pressure.
- Maximum difference in output at any pressure with the operating pressure range and temperature within 0°C to 50°C after:
  - 100 temperature cycles, 0°C to 50°C
  - 1.0 million pressure cycles, 0 psi to full-scale span
- Response time for a 0 psi to full-scale span pressure step change. 10% to 90% rise time
- Temp effect on span and offset are guaranteed by design. Therefore these parameters are not 100% tested.
- The SCC100D devices can only be used in a forward gauge mode. Application of more than 30 psig to the back side of any of the SCC Series devices can result in device failure.

**PHYSICAL DIMENSIONS**

**Button Package**

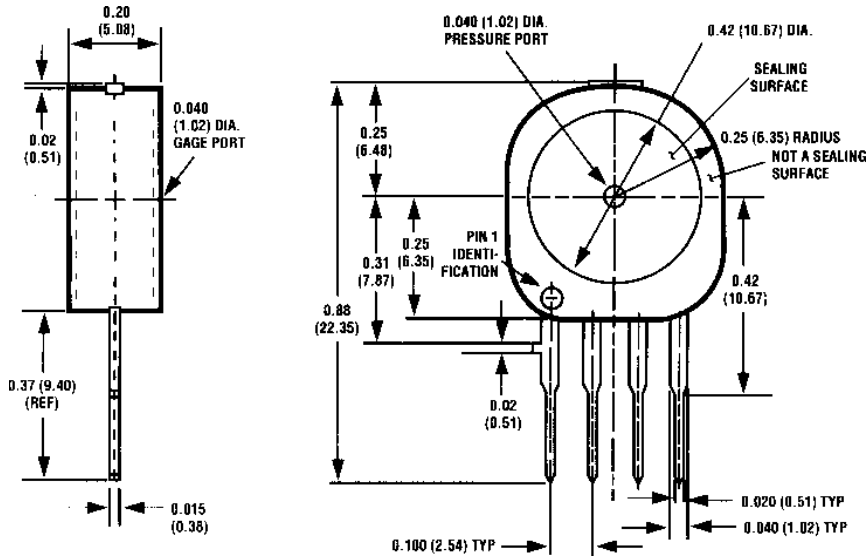

**Basic Sensor DIP "D2" Package**

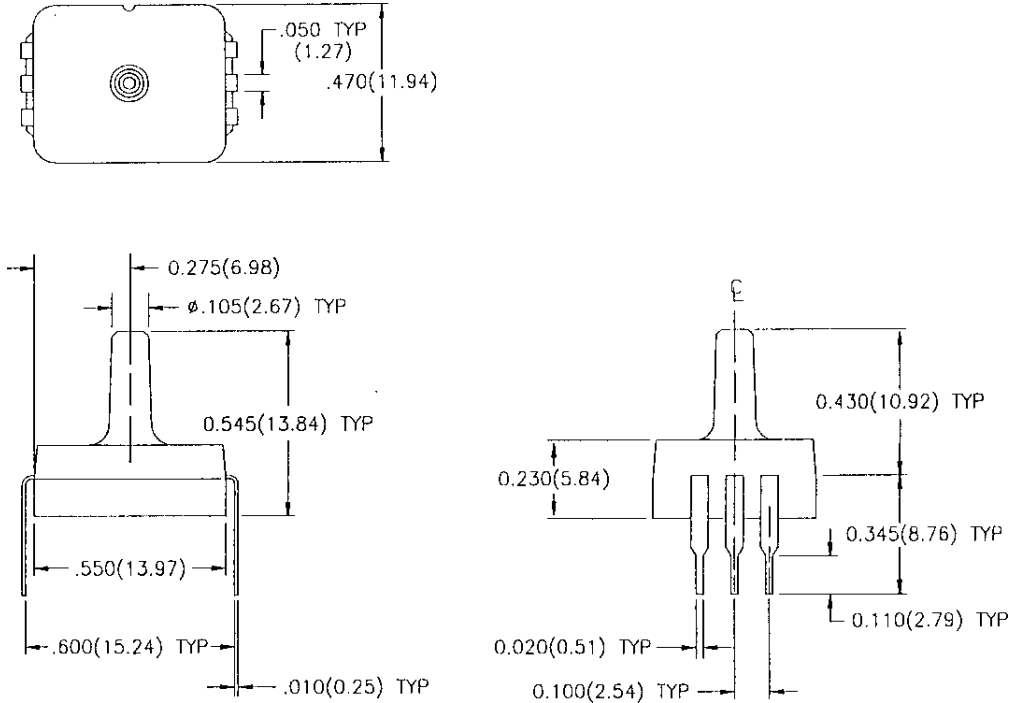

**PHYSICAL DIMENSIONS (cont.)**

**Basic Sensor DIP "D4" Package**

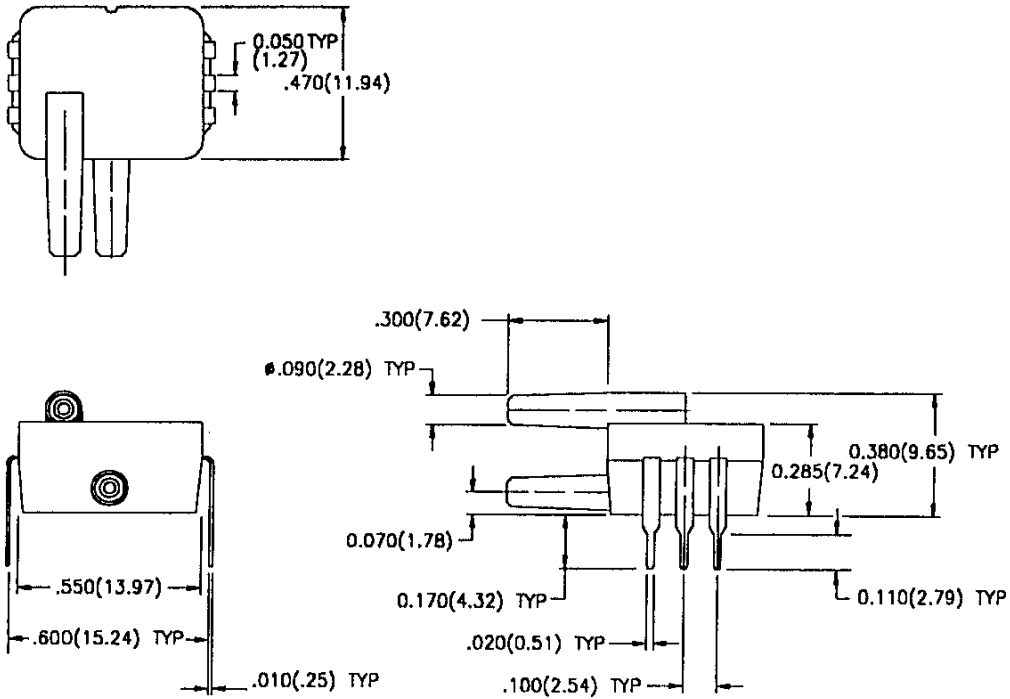

**N Package**

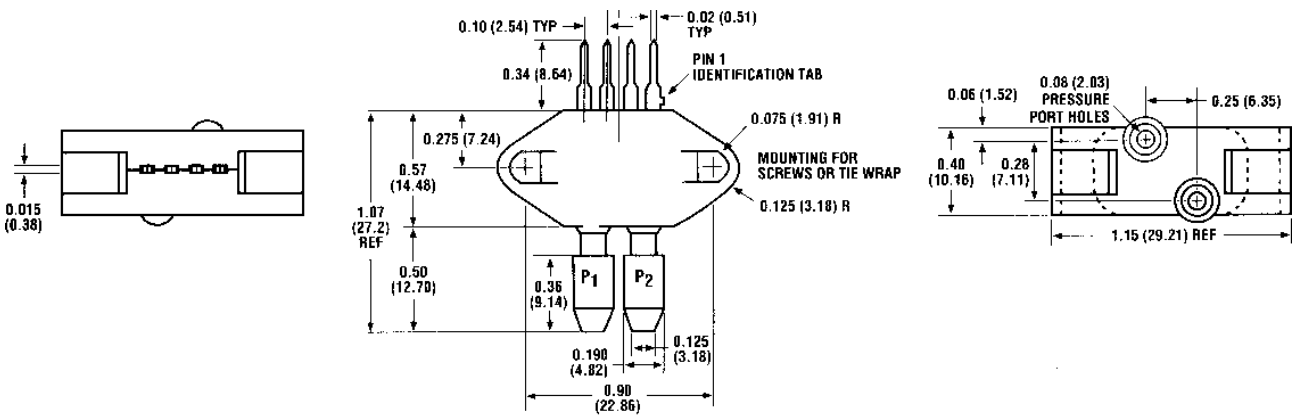

### PHYSICAL DIMENSIONS (cont.)

#### AHO Package (TO-5)

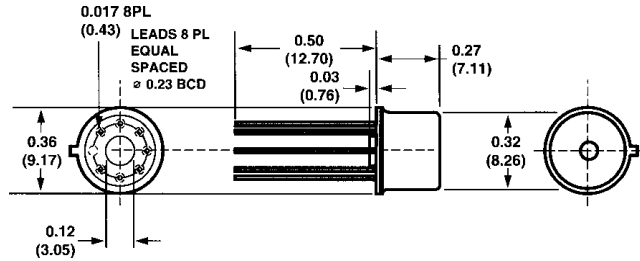

#### GSO Package (TO-39)

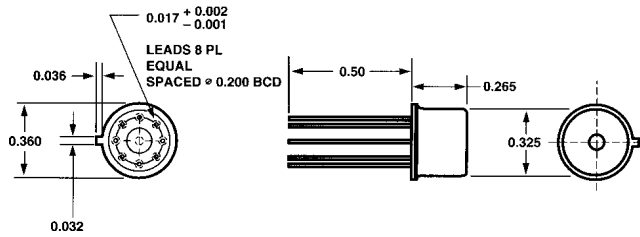

### ORDERING INFORMATION

Pressure Range	Order Part Number				
	Button Package	"N" Package	TO Package	DIP Package single port	DIP Package Dual port
Absolute Pressure					
0 - 15 psi	SCC15A	SCC15AN	SCC15AHO	SCC15AD2	---
0 - 30 psi	SCC30A	SCC30AN	SCC30AHO	SCC30AD2	---
0 - 100 psi	SCC100A	SCC100AN	SCC100AHO	SCC100AD2	---
0 - 300 psi	---	---	SCC300AHO	---	---
Gage Pressure					
0 - 5 psi	use differential devices	use differential devices	SCC05GSO	SCC05GD2	---
0 - 15 psi			SCC15GSO	SCC15GD2	---
0 - 30 psi			SCC30GSO	SCC30GD2	---
0 - 100 psi			---	---	---
Differential Pressure					
0 - 5 psi	SCC05D	SCC05DN	---	---	SCC05DD4
0 - 15 psi	SCC15D	SCC15DN	---	---	SCC15DD4
0 - 30 psi	SCC30D	SCC30DN	---	---	SCC30DD4
0 - 100 psi <sup>(9)</sup>	SCC100D	SCC100DN	---	---	SCC100DD4

SenSym and Sensortechonics reserve the right to make changes to any products herein. SenSym and Sensortechonics do not assume any liability arising out of the application or use of any product or circuit described herein, neither does it convey any license under its patent rights nor the rights of others.